



▲ Model 120 shown

The OCV Series 120 Rate of Flow control valve is designed to control or limit flow to a predetermined rate, regardless of fluctuations in downstream or upstream pressure.

## SERIES FEATURES

- ▶ Self contained, including the differential-sensing orifice plate and pilot.
- ▶ Flow rate is field adjustable (within orifice bore range)
- ▶ Extra-sensitive-differential pilot specifically designed for Rate-of-Flow application.
- ▶ Works equally well on all types of clean, non-abrasive liquids.

## VALVE FEATURES

- ▶ Operates automatically off line pressure.
- ▶ Heavy-duty, nylon-reinforced diaphragm.
- ▶ Rectangular-shaped, soft seat seal provides drip-tight Class VI closure.
- ▶ Diaphragm assembly guided top and bottom.
- ▶ Throttling seat retainer for flow and pressure stability.
- ▶ Easily maintained without removal from the line.
- ▶ Replaceable seat ring.
- ▶ Alignment pins assure proper reassembly after maintenance.
- ▶ Valves are factory tested.
- ▶ Valves are serial numbered and registered to facilitate replacement parts and factory support.

## WATER DISTRIBUTION SYSTEM

Where two water districts are connected, the valve limits flow rate between the two.

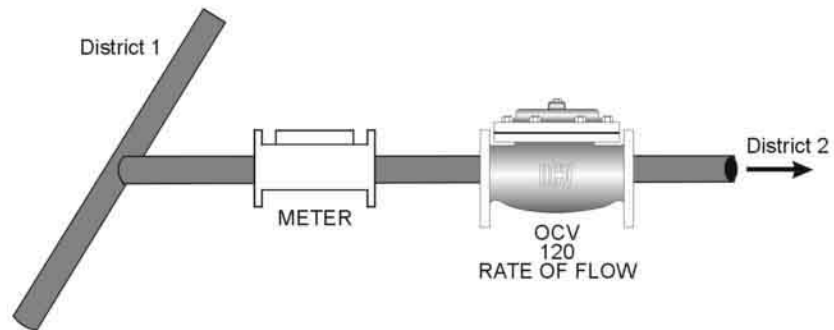

## FILTER BACKWASH CONTROL

Installed in the backwash line, the valve limits flow rate during the backwash cycle to prevent filter media blow out.

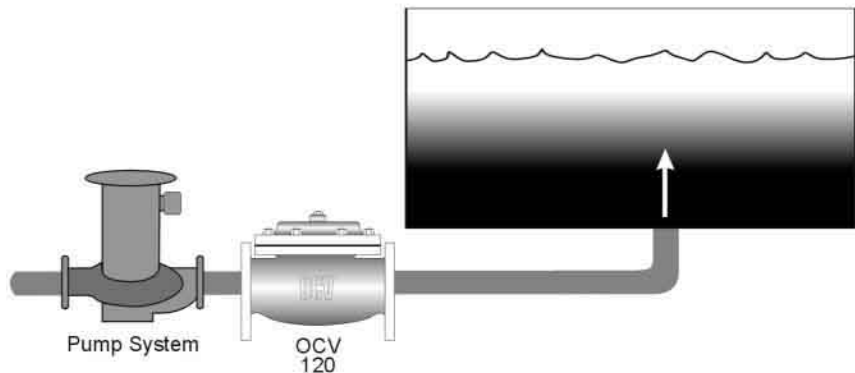

## VALVE OPERATION

### The OCV Model 120

▶ The OCV Model 120 rate-of-flow control valve is designed to control or limit flow to a constant, predetermined rate regardless of fluctuations in upstream or downstream pressure. It consists of the following components.

- 1.) **Model 65 Basic Valve**, a hydraulically-operated, diaphragm-actuated, globe or angle valve with an elastomer-on-metal seal and throttling seat retainer.
- 2.) **Orifice Plate**, installed integral to the main valve's inlet flange. The orifice plate is the flow-sensing device for the rate-of-flow pilot. Orifice plate bore is sized for application flow range.
- 3.) **Model 2450 Rate-of-Flow Control Pilot**, a two-way, normally-open pilot valve that senses the differential pressure created across the orifice plate and balances it against an adjustable spring load. This differential is proportional to the flow rate through the valve. An increase in differential tends to make the pilot close.
- 4.) **Model 126 Ejector**, a simple "tee" fitting with a fixed orifice in its upstream port. It provides the proper pressure to the diaphragm chamber of the main valve depending on the position of the rate-of-flow pilot.
- 5.) **Model 141-2 Needle Valve**, that controls the opening and closing speed of the main valve.
- 6.) **Model 159 Y-Strainer** (standard on water service valves). The strainer protects the pilot system from solid contaminants in the line fluid.
- 7.) **Two Model 141-4 Ball Valves** (standard on water service valves, optional on fuel service valves), useful for isolating the pilot system for maintenance or troubleshooting.

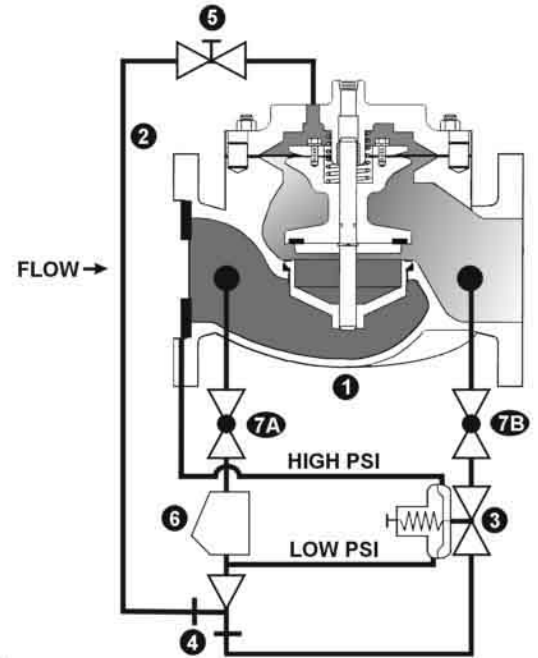

## EXCESS FLOW SHUT-OFF VALVE

### The OCV Model 128

The OCV Model 128, excess flow shut-off valve closely resembles the standard model 120 Rate-of-Flow control valve. However, in place of the previously described rate of flow pilot model 2450, the 128 is equipped with an adjustable, spring-loaded, locked-open pilot that is non-modulating (model 1380). As long as the differential pressure across the orifice plate (flow rate) is less than the pilot setting, the valve remains open. Should the orifice plate differential exceed the setting of the pilot, the pilot "trips" closed and fully closes the main valve. The pilot and main valve remain closed until manually reset.

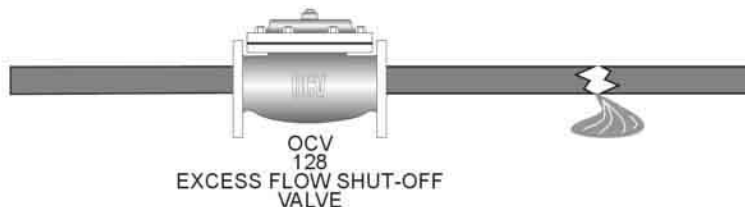

The OCV Model 128 is therefore valuable in protecting against a break in the downstream pipe.

Model 1380 Excess Flow Pilot Material of Construction: Stainless Steel  
Orifice Plate: Stainless Steel

**TOLL FREE 1.888.628.8258** • phone: (918)627.1942 • fax: (918)622.8916 • 7400 East 42nd Place, Tulsa, Oklahoma 74145  
email: [sales@controlvalves.com](mailto:sales@controlvalves.com) • website: [www.controlvalves.com](http://www.controlvalves.com)

## SIZING CONSIDERATIONS

### Flow Characteristics

Based upon standard orifice plate bore size with water as the flowing media. Consult factory for other liquids and flow rates.

SIZE	1 1/4"	1 1/2"	2"	2 1/2"	3"	4"	6"	8"	10"	12"	14"	16"	24"
Min. flow, gpm	30	30	50	70	115	200	450	750	1050	1500	1800	2400	7000
Max. flow, gpm	120	120	200	280	460	800	1800	3000	4200	6000	7200	9600	28000

### Sizing Rate of Flow Control Valves

Using the flow characteristics chart above, select the size where the design flow rate comes closest to the middle of the flow range shown. For example, for 300 gpm, the best size would be a 3".

Sometimes a valve selected in this manner will be less than line size, and there may not be room for reducers. By changing to a smaller-than-standard orifice plate, larger valves can be used at lower flow rates than those shown. Consult factory for details.

For a comprehensive guide to sizing, refer to OCV ValveMaster Sizing & Selection software.

### PILOT 2450: Rate of Flow Pilot

- ▶ Pilot is field adjustable (within orifice bore range)
- ▶ Large diaphragm area for sensing small changes in differential pressure.
- ▶ Hydraulically balanced design for accurate control.
- ▶ Specifically designed for rate of flow control.

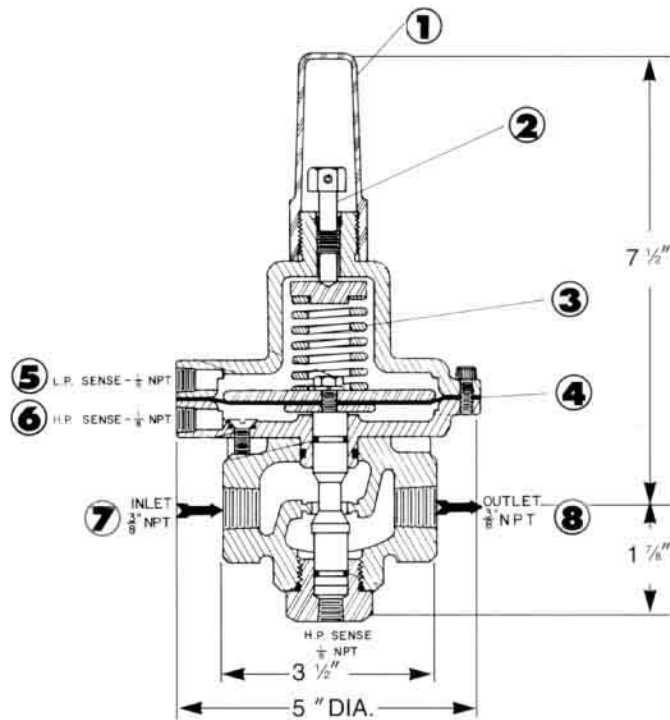

#### INSTALLATION

The 120 is furnished fully factory-assembled and ready for installation at the appropriate point in the system. Install the valve referencing the flow arrow tag. The orifice plate will be in the inlet flange. It is recommended that at least five diameters of straight pipe be allowed upstream of the valve.

#### PILOT VALVE OPERATION

The model 2450 is a normally-open, double-acting, spring-loaded, diaphragm pilot valve (see illustration). Control piping provides for sensing differential pressure across the valve inlet orifice plate. The upstream (high pressure) side is sensed under the pilot diaphragm; the downstream (low pressure) side over the diaphragm. Closing of the pilot is assisted by the adjustable spring. Flow rate may be changed by the adjusting screw. The pilot is adjustable within a 4:1 ratio, depending on the orifice size used.

Variations in pressure differential across the orifice plate produce modulation in the double-acting pilot, which in turn creates a mirror-modulation in the main valve. Increased differential pressure works to close the valve while a drop in such pressure opens it.

1. Adjusting Screw Cover
2. Adjustment Screw
3. Spring
4. Diaphragm
5. Orifice Plate Low-Pressure Sensing Port
6. Orifice Plate High-Pressure Sensing Port
7. Pilot Inlet
8. Pilot Outlet

## VALVE SELECTION GUIDE

By combining various control pilots, multiple valve functions can be performed on a single Series 120 Rate-of-Flow Control Valve. To find the combination function valve, select the desired features and then the model number.

This chart shows only a sample of the most often specified valves. Consult the factory for specific data on the model you selected.

Combination valves can often reduce or eliminate other equipment. Example: If the system requires a Pressure-Reducing function, the feature can be added as a function of the Rate-of-Flow Valve, Model 120-2.

Feature	120	120-1	120-2	120-3	120-6	120-7	120-12	120-13	120-16	120-26	120-36	120-126	120-136	Definition
Rate of Flow	X	X	X	X	X	X	X	X	X	X	X	X	X	Regulates or limits flow rate to desired setting.
Check Valve					X				X	X	X	X	X	Closes valve on pressure reversal
Two-Stage Opening and/or Closing						X								Solenoid controlled opens/closes valve in two stages
Pressure Reducing			X				X			X		X		Reduces higher inlet pressure to lower outlet
Solenoid Shutoff		X					X	X	X			X	X	Opens and closes valve electrically
Pressure Sustaining				X				X			X		X	Maintains minimum valve inlet pressure

## ABOUT YOUR VALVE

OCV Control Valves was founded more than 50 years ago with a vision and commitment to quality and reliability. From modest beginnings, the company has grown to be a global leader just a half century later. In fact, OCV Valves can be found in some capacity in nearly every country around the world from fire protection systems in Malaysia to aircraft fueling systems in Africa and from oil refineries in Russia to water supply systems in the USA and Canada. You will also find our valves in irrigation systems in Europe, South America and the Middle East.

The original foundation on which the company was built allows our team of professionals to not only provide the service required to be a worldwide supplier, but more importantly the opportunity to afford the personal touch necessary to be each of our customers' best partner. Simply stated, we take pride in all that we do.

Committed to the work they do, our employees average over 15 years of service. This wealth of knowledge allows us to provide quality engineering, expert support, exacting control and the know-how to create valves known for their long life.

Being ISO 9001 certified means we are committed to a quality assurance program. Our policy is to supply each customer with consistent quality products and ensure that the process is right every time. Our valves meet and exceed industry standards around the world, including approvals by:



All valves are not created equal. OCV Control Valves proves that day in and day out. We stand behind our valves and are ready to serve your needs.

TOLL FREE 1.888.628.8258 • phone: (918)627.1942 • fax: (918)622.8916 • 7400 East 42nd Place, Tulsa, OK 74145  
email: sales@controlvalves.com • website: www.controlvalves.com

**Global performance. Personal touch.**

## SPECIFICATIONS

VALVE BODY & BONNET	DUCTILE IRON		CAST STEEL		CAST BRONZE		STAINLESS STEEL	
<b>Material Specifications</b>	ASTM A536 (epoxy coated)		ASTM A216/WCB (epoxy coated)		ASTM B61		ASTM A743/CF8M	
<b>END CONNECTIONS</b>								
Flange Standard (also available in metric)	ANSI B16.42		ANSI B16.5		ANSI B16.24		ANSI B16.5	
Flange Class	150#	300#	150#	300#	150#	300#	150#	300#
Flange Face	Flat	Raised	Raised	Raised	Flat	Flat	Raised	Raised
Maximum Working Pressure	250 psi	640 psi	285 psi	740 psi	225 psi	500 psi	285 psi	740 psi
Screwed Working Pressure:	ANSI B1.20.1 (B2.1) 640 psi (Bronze 500 psi)		Grooved End Working Pressure:		300 psi			
<b>INTERNALS</b>								
Stem	STAINLESS STEEL AISI 303				OPTIONAL MONEL			
Spring	STAINLESS STEEL AISI 302							
Spool	DUCTILE IRON ASTM A536 (epoxy coated)				B-61		STN. STL. ASTM A 743/CF8M	
Seat Disc Retainer	DUCTILE IRON ASTM A536 (epoxy coated) 4" & SMALLER VALVES - STAINLESS STEEL				B-61		STAINLESS STEEL	
Diaphragm Plate	DUCTILE IRON ASTM A536 (epoxy coated)				B-61		STAINLESS STEEL	
Seat Ring (Trim)	BRONZE B61 OPTIONAL STAINLESS STEEL ASTM A743/CF8M						STN. STL. ASTM A 743/CF8M	
Upper Stem Bushing	STANDARD BRONZE ASTM B438		VALVE W/ STAINLESS STEEL SEAT RING-TEFLON			TEFLON		
Lower Stem Bushing	SEAT MATERIAL VALVES W/ STAINLESS STEEL SEAT RING-TEFLON						TEFLON	
<b>ELASTOMER PARTS (Rubber)</b>								
Diaphragm/Seat Disc/O-Rings	STANDARD - BUNA-N NYLON REINFORCED				OPTIONAL - VITON®		OPTIONAL - EPDM	
Operating Temperature	-40°F to 180°F				32°F to 400°F		0°F to 300°F	
<b>COATINGS</b>								
WIDE RANGE OF COATING PER YOUR FLUID APPLICATION. COATINGS HANDLE MUNICIPAL POTABLE WATER, SEAWATER, PETROLEUM AND REFINED PRODUCTS.								
<b>ELECTRICAL SOLENOIDS</b>								
Bodies	STANDARD BRASS				STAINLESS STEEL (OPTIONAL)			
Elastomers	STANDARD - BUNA-N NYLON REINFORCED				OPTIONAL - VITON®			
Enclosures	WATER TIGHT, NEMA 1, 3, 4, & 4X - EXPLOSION PROOF - OPTIONAL (NEMA 7 & 9)							
Power	AC, 60HZ - 24, 120, 240, 480 VOLTS		AC, 50HZ - In 110 VOLT MULTIPLES		DC, 6, 12, 24, 240 VOLTS			
Operation	ENERGIZE TO OPEN (NORMALLY CLOSED)				DE-ENERGIZE TO OPEN (NORMALLY OPEN)			
<b>CONTROL PILOTS</b>								
Bodies	BRONZE B61		STAINLESS STEEL ASTM A743/CF8M					
Internal	AIS I 303							
<b>CONTROL CIRCUITS</b>								
Tubing	COPPER OR STAINLESS STEEL							
Fittings	BRASS OR STAINLESS STEEL							

### SALTWATER SERVICE VALVE MATERIALS

Cast Steel Special Coatings --Ni Aluminum Bronze ASTM B148 --Super Duplex Stainless Steel



#### Globe Flanged Sizes

1.25"	1.5"	2"	2.5"	3"	4"	6"	8"	10"	12"	14"	16"	18"	20"	24"
32mm	40mm	50mm	65mm	80mm	100mm	150mm	200mm	250mm	300mm	350mm	400mm	450mm	500mm	600mm

\*CONSULT FACTORY



#### Angle Flanged Sizes

1.25"	1.5"	2"	2.5"	3"	4"	6"	8"	10"	12"	16"
32mm	40mm	50mm	65mm	80mm	100mm	150mm	200mm	250mm	300mm	400mm



#### Globe/Angle Screwed Sizes

1.25"	1.5"	2"	2.5"	3"
32mm	40mm	50mm	65mm	80mm



#### Globe/Angle Grooved Sizes

1.5"	2"	2.5"	3"	4"
32mm	50mm	65mm	80mm	100mm

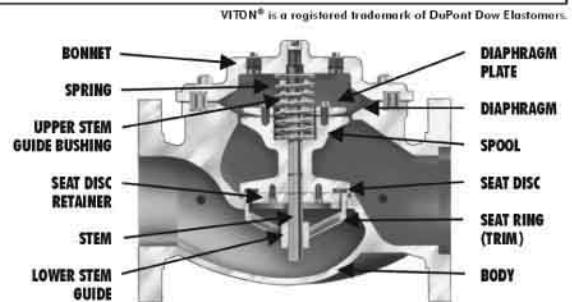

TOLL FREE 1.888.628.8258 • phone: (918)627.1942 • fax: (918)622.8916 • 7400 East 42nd Place, Tulsa, OK 74145  
email: sales@controlvalves.com • website: www.controlvalves.com

## DIMENSIONS

U.S. DIMENSIONS - INCHES

DIM	END CONN.	1 1/4-1 1/2	2	2 1/2	3	4	6	8	10	12	14	16	24
A	150# FLGD	8 1/2	9 3/8	10 1/2	12	15	17 3/4	25 3/8	29 3/4	34	39	40 3/8	62
	300# FLGD	8 3/4	9 7/8	11 1/8	12 3/4	15 5/8	18 5/8	26 3/8	31 1/8	35 1/2	40 1/2	42	63 3/4
B	150# FLGD	2 5/16-2 1/2	3	3 1/2	3 3/4	4 1/2	5 1/2	6 3/4	8	9 1/2	10 5/8	11 3/4	16
	300# FLGD	2 5/8-3 1/16	3 1/4	3 3/4	4 1/8	5	6 1/4	7 1/2	8 3/4	10 1/4	11 1/2	12 3/4	18
C	150# FLGD	4 1/4	4 3/4	6	6	7 1/2	10	12 11/16	14 7/8	17	--	20 13/16	--
	ANGLE 300# FLGD	4 3/8	5	6 3/8	6 3/8	7 13/16	10 1/2	13 3/16	15 9/16	17 3/4	--	21 5/8	--
D	150# FLGD	3	3 7/8	4	4	5 1/2	6	8	11 3/8	11	--	15 11/16	--
	ANGLE 300# FLGD	3 1/8	4 1/8	4 3/8	4 3/8	5 13/16	6 1/2	8 1/2	12 1/16	11 3/4	--	16 1/2	--
E	ALL	6	6	7	6 1/2	8	10	11 7/8	15 3/8	17	18	19	27
F	ALL	3 7/8	3 7/8	3 7/8	3 7/8	3 7/8	3 7/8	6 3/8	6 3/8	6 3/8	6 3/8	6 3/8	8
G	ALL	6	6 3/4	7 11/16	8 3/4	11 3/4	14	21	24 1/2	28	31 1/4	34 1/2	52
H	ALL	10	11	11	11	12	13	14	17	18	20	20	28 1/2

METRIC DIMENSIONS - M.M.

DIM	END CONN.	DN32-DN40	DN50	DN65	DN80	DN100	DN150	DN200	DN250	DN300	DN350	DN400	DN600
A	150# FLGD	216	238	267	305	381	451	645	756	864	991	1026	1575
	300# FLGD	222	251	283	324	397	473	670	791	902	1029	1067	1619
B	150# FLGD	59-64	76	89	95	114	140	171	203	241	270	298	406
	300# FLGD	67-78	83	95	105	127	159	191	222	260	292	324	457
C	150# FLGD	108	121	152	152	191	254	322	378	432	--	529	--
	ANGLE 300# FLGD	111	127	162	162	198	267	335	395	451	--	549	--
D	150# FLGD	76	98	102	102	140	152	203	289	279	--	398	--
	ANGLE 300# FLGD	79	105	111	111	148	165	216	306	298	--	419	--
E	ALL	152	152	178	165	203	254	302	391	432	457	483	686
F	ALL	98	98	98	98	98	98	162	162	162	162	162	203
G	ALL	152	171	195	222	298	356	533	622	711	794	876	1321
H	ALL	254	279	279	279	305	330	356	432	457	508	508	724

For maximum efficiency, the OCV control valve should be mounted in a piping system so that the valve bonnet (cover) is in the top position. Other positions are acceptable but may not allow the valve to function to its fullest and safest potential. In particular, please consult the factory before installing 8" and larger valves, or any valves with a limit switch, in positions other than described. Space should be taken into consideration when mounting valves and their pilot systems.

A routine inspection & maintenance program should be established and conducted yearly by a qualified technician. Consult our factory @ **1-888-628-8258** for parts and service.

### How to order your valve

When Ordering please provide:  
 Series Number - Valve size - Globe or Angle -  
 Pressure Class - Screwed, Flanged, Grooved -  
 Trim Material - Adjustment Range - Pilot  
 Options - Special needs / or installation requirements.

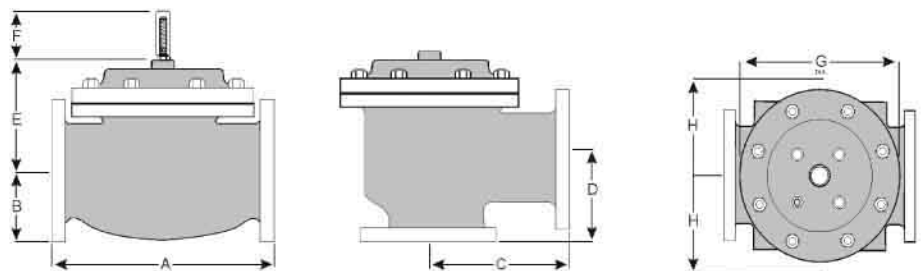

Represented by: