



▲ Model 127-3 shown

The OCV Pressure-Reducing Valve is used in many applications worldwide. The primary function of the 127 series is to reduce a greater upstream pressure to a lesser, more manageable downstream pressure, operating without regard to either upstream supply or downstream demand.

## SERIES FEATURES

- ▶ Reduces higher inlet pressure to a constant lower outlet pressure.
- ▶ Outlet pressure is accurate over wide range of flow.
- ▶ Pilot-operated main valve is not subject to pressure fall off characteristic of direct-acting PRV's.
- ▶ Outlet pressure is adjustable over complete range of control spring (see pilot features).

## VALVE FEATURES

- ▶ Operates automatically off line pressure.
- ▶ Heavy-duty, nylon-reinforced diaphragm.
- ▶ Rectangular-shaped, soft seat seal provides drip-tight Class VI closure.
- ▶ Diaphragm assembly Guided top and bottom
- ▶ Throttling seat retainer for flow and pressure stability.
- ▶ Easily maintained without removal from the line.
- ▶ Replaceable seat ring.
- ▶ Alignment pins assure proper reassembly after maintenance.
- ▶ Valves are factory tested.
- ▶ Valves are serial numbered and registered to facilitate replacement parts and factory support.

Regardless of the source of high pressure, the 127-3 reduces that pressure to a constant discharge pressure, despite fluctuations in the demand or inlet pressure. Here, a parallel valve arrangement is used to handle a wide range of demand. (see Sizing Pressure Reducing Valves)

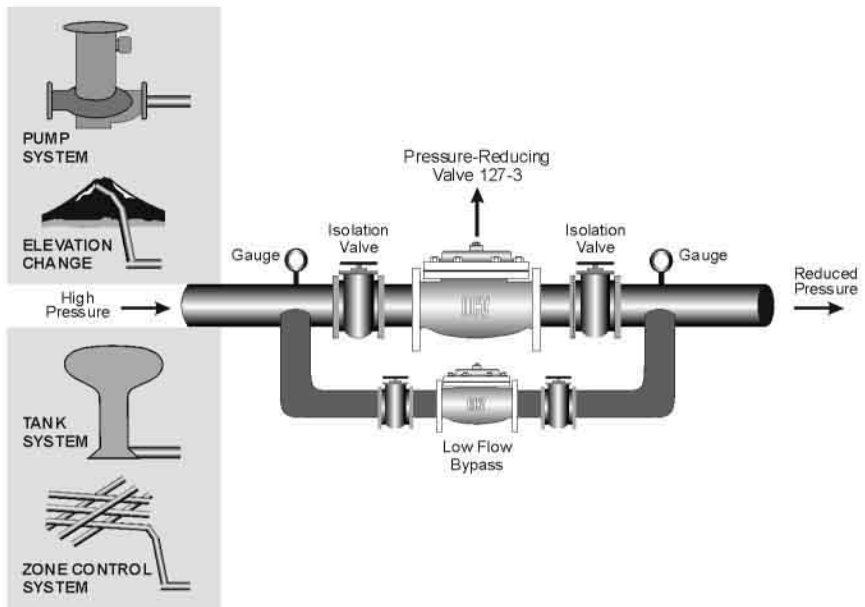

## VALVE OPERATION

### The OCV Model 127-3

- ▶ Maintains a constant downstream pressure despite fluctuations in demand and inlet pressure.
  - ▶ Assuming proper sizing and adjustment, the 127-3 will maintain downstream pressure at the set point  $\pm 2$  psi.
- 1.) **Model 65 Basic Control Valve**, a hydraulically-operated, diaphragm-actuated globe or angle valve which closes with an elastomer-on-metal seal.
  - 2.) **Model 1340 Pressure-Reducing Pilot**, a two-way, normally-open pilot valve which senses downstream pressure under its diaphragm and balances it against an adjustable spring load. An increase in downstream pressure tends to make the pilot close.
  - 3.) **Model 126 Ejector**, a simple "tee" fitting with a fixed orifice in its upstream port. It provides the proper pressure to the diaphragm chamber of the main valve, depending on the position of the pressure-reducing pilot.
  - 4.) **Model 141-3 Flow Control Valve**, a needle-type valve which provides adjustable, restricted flow in one direction and free flow in the opposite direction. On the 127-3, the flow control valve is connected as an opening speed control.
  - 5.) **Model 159 Y-Strainer**, (standard on water service valves), the strainer protects the pilot system from solid contaminants in the line fluid.
  - 6.) **Two Model 141-4 Ball Valves**, (standard on water service valves, optional on fuel service valves), useful for isolating the pilot system for maintenance or troubleshooting.

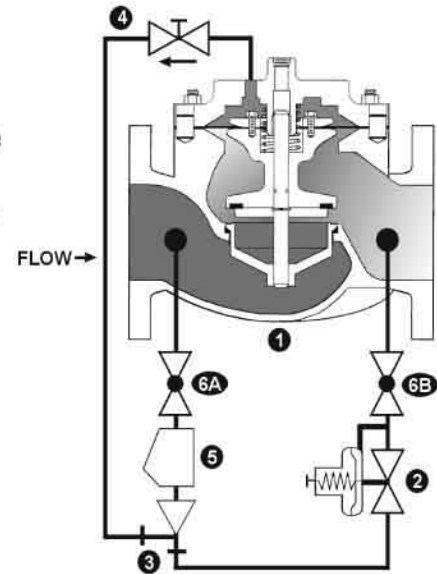

## PILOT

1340  
2420

- ▶ Accurate sensing of outlet pressure.
- ▶ Simple, single adjustment.
- ▶ All parts replaceable while mounted on valve.
- ▶ Rubber-to-metal seat for positive shut-off.
- ▶ Large area diaphragm for quick, precise throttling.
- ▶ Visual indication of diaphragm condition.
- ▶ Bronze and stainless steel construction.

### 1340

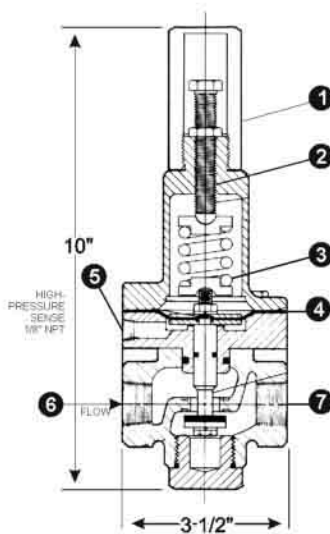

#### Pilot Materials

Bronze B-61  
Stainless Steel ASTM A743/CF8M

#### Spring Ranges

5-30, 20-80, 65-180, 100-300 psi

### 2420

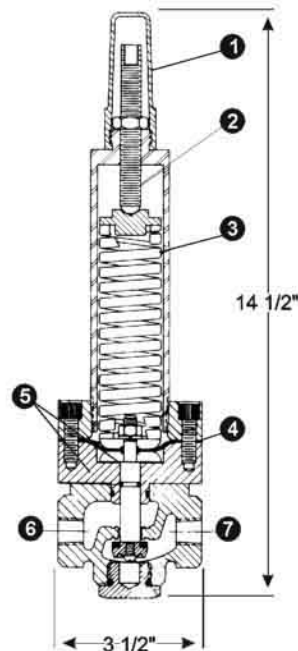

#### Pilot Materials

Stainless Steel ASTM A743/CF8M

#### Spring Ranges

200-750 psi

The Model 1340 & 2420 Pressure Reducing Pilot controls the amount of pressure in the upper chamber of the main valve (hence, the degree of opening or closing of the main valve). The downstream system pressure is sensed under the pilot to close, increasing the amount of pressure in the upper chamber of the main valve causing it to close a proportionate amount to maintain a constant discharge pressure. As the downstream pressure decreases, the pilot begins to open, allowing the pressure in the upper chamber of the main valve to decrease, causing the main valve to open. This is a constant modulating action compensating for any change in downstream system pressure.

#### MODEL 1340 / 2420 Pressure Reducing Pilot

1. Adjusting Screw Cover
2. Adjusting Screw
3. Spring
4. Diaphragm
5. Pressure Sense
6. Pilot Inlet
7. Pilot Outlet

## SIZING PRESSURE REDUCING VALVES

For the most comprehensive procedure in sizing pressure reducing valves, it is best to use our ValveMaster software or the Performance Charts in the Engineering Section of the OCV catalog. In the absence of these, the following procedure will get you where you need to be, and enable you to avoid the most common error in sizing PRVs: an oversized valve.

### Procedure

The following procedure takes both factors (flow rate/pressure drop) into account through the use of the flow coefficient, or Cv. The theory is simple: for best results, a PRV should be sized to operate between 10% and 90% of its capacity, or in other words, between 10% and 90% of its wide open Cv. It is a four-step procedure:

#### Step 1: Calculate Cv Minimum

Q Minimum = Minimum anticipated flow, GPM  
 S = Specific gravity of fluid (water = 1.0)  
 P1 = Inlet pressure at Q minimum, psi  
 Ps = Desired outlet pressure, psi

$$C_{vmin} = Q_{min} \sqrt{\frac{S}{P_1 - P_s}}$$

**Step 3:** From the table, find the size that includes both the Cv min. and Cv max. you have calculated in either the globe or angle valve column.

Occasionally, the flow range is so wide that both the Cv min. and Cv max. will not fit in the proper range for any one size valve. In such cases, a parallel valve installation, with a smaller valve by passing around a larger one, should be given strong consideration. The valves should be sized so that:

#### Step 2: Calculate Cv Maximum

Q Max. = Maximum anticipated flow, GPM  
 P2 = Inlet pressure at Q maximum, psi  
 Ps = Desired outlet pressure, psi

$$C_{vmax} = Q_{max} \sqrt{\frac{S}{P_2 - P_s}}$$

**Step 4:** From the table check that the velocity (GPM) at the calculated Q max. does not exceed 25 ft/sec.

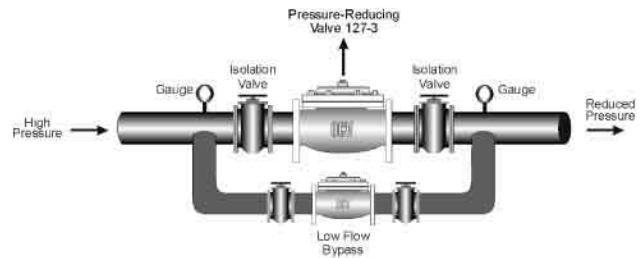

Valve Size	Globe Valves Cv Range	Angle Valves Cv Range	Flow for 25ft/sec GPM
1 1/4-1 1/2	2.3-21	3.7-33	115
2"	4.7-42	6.0-54	260
2 1/2"	6.8-61	7.8-70	370
3"	9.6-86	14-126	570
4"	20-180	27-243	1,000
6"	45-405	65-585	2,250
8"	76-684	100-900	3,900
10"	110-990	150-1350	6,150
12"	170-1530	250-2250	8,700
14"	215-1940	-----	10,500
16"	285-2570	300-2700	13,800
24"	690-6210	-----	31,300

### CAVIATION CONCERNS

Pressure reducing valves are, by their application, subject to pressure differentials that may induce cavitation. Often when these conditions exist, it may be only on an intermittent basis, causing minimum concern for valve deterioration.

Charts that index only inlet and outlet pressures cannot accurately predict this complex phenomenon. The easiest way to predict cavitation is to let us do the calculation. Simply fax, e-mail or call us and we will provide a graphical analysis and a solution, often simpler and less costly than the classic one: that of using two valves in series.

Provide us:

- 1.) VALVE SIZE
- 2.) INLET PRESSURE - OUTLET PRESSURE
- 3.) FLOW RANGE - Minimum - Maximum
- 4.) FLUID
- 5.) FLUID VAPOR PRESSURE (if other than water)

**TOLL FREE 1.888.628.8258** • phone: (918)627.1942 • fax: (918)622.8916 • 7400 East 42nd Place, Tulsa, Oklahoma 74145  
 email: sales@controlvalves.com • website: www.controlvalves.com

## VALVE SELECTION GUIDE

By combining various control pilots, multiple valve functions can be performed on a single Series 127 Pressure Reducing Valve. To find the combination function valve, select the desired features and then the model number.

This chart shows only a sample of those most often specified valves. Consult the factory for specific data on the model you selected.

Combination valves can often reduce or eliminate other equipment. Example: If the system requires a Pressure Reducing Valve and a Check Valve, the check feature can be added as a function of the PRV, Model 127-4.

Feature	127-2	127-3	127-4	127-5	127-7	127-9	127-22	127-25	127-27	127-32	127-42	127-45	127-80	127-82	127-245	127-280	127-420	127-480	127-580	127-2480	127-3BDF	Definition
Pressure Reducing	X	X	X	X	X	X	X	X	X	X	X	X	X	X	X	X	X	X	X	X	X	Reduces higher inlet pressure to lower outlet
Check Feature			X							X	X			X		X	X			X		Closes valve on pressure reversal
Solenoid Shutoff												X	X		X		X	X	X			Opens or closes valve electrically
Pressure Sustaining	X						X	X	X					X	X	X				X		Maintains minimum valve inlet pressure
Surge Control			X				X				X			X					X			Valve inlet pressure used to close valve on rise in outlet pressure
Reverse Flow Feature				X				X														Valve flows either direction
Bidirectional Reducing																					X	Dual pilot system controls in either flow direction
Two-Stage Opening and/or Closing (Electrical)					X																	Solenoid controlled opens / closes valve in two steps
Two-Stage Opening (Hydraulic)						X			X	X			X									Hydraulic pilots control valve opening in two steps

### HIGH PRESSURE / HP

When valve outlet pressure requires the model 2420 High Pressure Reducing pilot, an HP is added to the end of the model number. Example: Standard model 127-3 (outlet ranges from 5 - 300 psi) Model 127-3HP (outlet ranges 200-750 psi)

### LOW FLOW BY-PASS / LF

Most valves listed in this guide can be equipped with an integral Low Flow By-pass regulator, an LF is added to the end of the model number. Example: Model 127-3 with low flow by-pass is 127-3LF. Valve sizing is an important aspect in correct use of this feature.

## ABOUT YOUR VALVE

OCV Control Valves was founded more than 50 years ago with a vision and commitment to quality and reliability. From modest beginnings, the company has grown to be a global leader just a half century later. In fact, OCV Valves can be found in nearly every country around the world from fire protection systems in Malaysia to aircraft fueling systems in Africa and from oil refineries in Russia to water supply systems in the USA and Canada. You will also find our valves in irrigation systems in Europe, South America and the Middle East.

The original foundation on which the company was built allows our team of professionals to not only provide the service required to be a worldwide supplier, but more importantly the opportunity to afford the personal touch necessary to be each of our customers' best partner. Simply stated, we take pride in all that we do.

Committed to the work they do, our employees average over 15 years of service. This wealth of knowledge allows us to provide quality engineering, expert support, exacting control and the know-how to create valves known for their long life.

Being ISO 9001 certified means we are committed to a quality assurance program. Our policy is to supply each customer with consistent quality products and ensure that the process is right every time. Our valves meet and exceed industry standards around the world. Including approvals by:



All valves are not created equal. OCV Control Valves proves that day in and day out. We stand behind our valves and are ready to serve your needs.

TOLL FREE 1.888.628.8258 • phone: (918)627.1942 • fax: (918)622.8916 • 7400 East 42nd Place, Tulsa, OK 74145  
email: sales@controlvalves.com • website: www.controlvalves.com

**Global** performance. **Personal** touch.

## SPECIFICATIONS

VALVE BODY & BONNET	DUCTILE IRON		CAST STEEL		CAST BRONZE		STAINLESS STEEL	
<b>Material Specifications</b>	ASTM A536 (epoxy coated)		ASTM A216/WCB (epoxy coated)		ASTM B61		ASTM A743/CF8M	
<b>END CONNECTIONS</b>								
Flange Standard (also available in metric)	ANSI B16.42		ANSI B16.5		ANSI B16.24		ANSI B16.5	
Flange Class	150#	300#	150#	300#	150#	300#	150#	300#
Flange Face	Flat	Raised	Raised	Raised	Flat	Flat	Raised	Raised
Maximum Working Pressure	250 psi	640 psi	285 psi	740 psi	225 psi	500 psi	285 psi	740 psi
Screwed Working Pressure:	ANSI B1.20.1 (B2.1) 640 psi (Bronze 500 psi)		Grooved End Working Pressure:		300 psi			
<b>INTERNALS</b>								
Stem	STAINLESS STEEL AISI 303				OPTIONAL MONEL			
Spring	STAINLESS STEEL AISI 302							
Spool	DUCTILE IRON ASTM A536 (epoxy coated)				B-61		STN. STL. ASTM A 743/CF8M	
Seat Disc Retainer	DUCTILE IRON ASTM A536 (epoxy coated) 4" & SMALLER VALVES - STAINLESS STEEL				B-61		STAINLESS STEEL	
Diaphragm Plate	DUCTILE IRON ASTM A536 (epoxy coated)				B-61		STAINLESS STEEL	
Seat Ring (Trim)	BRONZE B61 OPTIONAL STAINLESS STEEL ASTM A743/CF8M						STN. STL. ASTM A 743/CF8M	
Upper Stem Bushing	STANDARD BRONZE ASTM B438		VALVE W/ STAINLESS STEEL SEAT RING-TEFLON				TEFLON	
Lower Stem Bushing	SEAT MATERIAL VALVES W/ STAINLESS STEEL SEAT RING-TEFLON						TEFLON	
<b>ELASTOMER PARTS (Rubber)</b>								
Diaphragm/Seat Disc/O-Rings	STANDARD - BUNA-N NYLON REINFORCED				OPTIONAL - VITON®		OPTIONAL - EPDM	
Operating Temperature	-40°F to 180°F				32°F to 400°F		0°F to 300°F	
<b>COATINGS</b> WIDE RANGE OF COATING PER YOUR FLUID APPLICATION. COATINGS HANDLE MUNICIPAL POTABLE WATER, SEAWATER, PETROLEUM AND REFINED PRODUCTS.								
<b>ELECTRICAL SOLENOIDS</b>								
Bodies	STANDARD BRASS				STAINLESS STEEL (OPTIONAL)			
Elastomers	STANDARD - BUNA-N NYLON REINFORCED				OPTIONAL - VITON®			
Enclosures	WATER TIGHT, NEMA 1, 3, 4, & 4X - EXPLOSION PROOF - OPTIONAL (NEMA 7 & 9)							
Power	AC, 60HZ - 24, 120, 240, 480 VOLTS		AC, 50HZ - In 110 VOLT MULTIPLES			DC, 6 12, 24, 240 VOLTS		
Operation	ENERGIZE TO OPEN (NORMALLY CLOSED)				DE-ENERGIZE TO OPEN (NORMALLY OPEN)			
<b>CONTROL PILOTS</b>								
Bodies	BRONZE B61	STAINLESS STEEL ASTM A743/CF8M						
Internal	AISI 303							
<b>CONTROL CIRCUITS</b>								
Tubing	COPPER OR STAINLESS STEEL							
Fittings	BRASS OR STAINLESS STEEL							

VITON® is a registered trademark of DuPont Dow Elastomers.

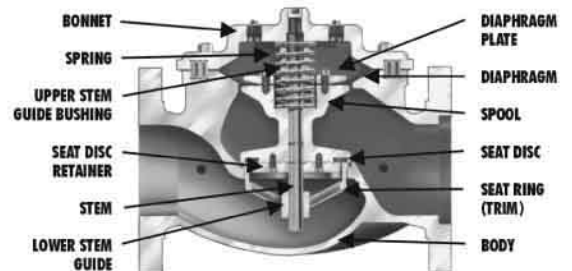

### SALTWATER SERVICE VALVE MATERIALS

Cast Steel Special Coatings --Ni Aluminum Bronze ASTM B148 --Super Duplex Stainless Steel



#### Globe Flanged Sizes

1.25"	1.5"	2"	2.5"	3"	4"	6"	8"	10"	12"	14"	16"	18"	20"	24"
32mm	40mm	50mm	65mm	80mm	100mm	150mm	200mm	250mm	300mm	350mm	400mm	450mm	500mm	600mm

\*CONSULT FACTORY



#### Angle Flanged Sizes

1.25"	1.5"	2"	2.5"	3"	4"	6"	8"	10"	12"	16"
32mm	40mm	50mm	65mm	80mm	100mm	150mm	200mm	250mm	300mm	400mm



#### Globe/Angle Screwed Sizes

1.25"	1.5"	2"	2.5"	3"
32mm	40mm	50mm	65mm	80mm



#### Globe/Angle Grooved Sizes

1.5"	2"	2.5"	3"	4"
32mm	50mm	65mm	80mm	100mm

TOLL FREE 1.888.628.8258 • phone: (918)627.1942 • fax: (918)622.8916 • 7400 East 42nd Place, Tulsa, OK 74145  
 email: sales@controlvalves.com • website: www.controlvalves.com

## DIMENSIONS

### U.S. DIMENSIONS - INCHES

DIM	END CONN.	1 1/4-1 1/2	2	2 1/2	3	4	6	8	10	12	14	16	24
A	SCREWED	8 3/4	9 7/8	10 1/2	13	--	--	--	--	--	--	--	--
	GROOVED	8 3/4	9 7/8	10 1/2	13	15 1/4	20	--	--	--	--	--	--
	150# FLGD	8 1/2	9 3/8	10 1/2	12	15	17 3/4	25 3/8	29 3/4	34	39	40 3/8	62
	300# FLGD	8 3/4	9 7/8	11 1/8	12 3/4	15 5/8	18 5/8	26 3/8	31 1/8	35 1/2	40 1/2	42	63 3/4
B	SCREWED	1 7/16	1 11/16	1 7/8	2 1/4	--	--	--	--	--	--	--	--
	GROOVED	1*	1 3/16	1 7/16	1 3/4	2 1/4	3 5/16	--	--	--	--	--	--
	150# FLGD	2 5/16-2 1/2	3	3 1/2	3 3/4	4 1/2	5 1/2	6 3/4	8	9 1/2	10 5/8	11 3/4	16
	300# FLGD	2 5/8-3 1/16	3 1/4	3 3/4	4 1/8	5	6 1/4	7 1/2	8 3/4	10 1/4	11 1/2	12 3/4	18
C	SCREWED	4 3/8	4 3/4	6	6 1/2	--	--	--	--	--	--	--	--
	GROOVED	4 3/8*	4 3/4	6	6 1/2	7 5/8	--	--	--	--	--	--	--
	150# FLGD	4 1/4	4 3/4	6	6	7 1/2	10	12 11/16	14 7/8	17	--	20 13/16	--
ANGLE	300# FLGD	4 3/8	5	6 3/8	6 3/8	7 13/16	10 1/2	13 3/16	15 9/16	17 3/4	--	21 5/8	--
	SCREWED	3 1/8	3 7/8	4	4 1/2	--	--	--	--	--	--	--	--
	GROOVED	3 1/8*	3 7/8	4	4 1/2	5 5/8	--	--	--	--	--	--	--
D	150# FLGD	3	3 7/8	4	4	5 1/2	6	8	11 3/8	11	--	15 11/16	--
	300# FLGD	3 1/8	4 1/8	4 3/8	4 3/8	5 13/16	6 1/2	8 1/2	12 1/16	11 3/4	--	16 1/2	--
	ALL	6	6	7	6 1/2	8	10	11 7/8	15 3/8	17	18	19	27
F	ALL	3 7/8	3 7/8	3 7/8	3 7/8	3 7/8	3 7/8	6 3/8	6 3/8	6 3/8	6 3/8	6 3/8	8
G	ALL	6	6 3/4	7 11/16	8 3/4	11 3/4	14	21	24 1/2	28	31 1/4	34 1/2	52
H	ALL	10	11	11	11	12	13	14	17	18	20	20	28 1/2

\*GROOVED END NOT AVAILABLE IN 1 1/4"

### METRIC DIMENSIONS - M.M.

DIM	END CONN.	DN32-DN40	DN50	DN65	DN80	DN100	DN150	DN200	DN250	DN300	DN350	DN400	DN600
A	SCREWED	222	251	267	330	--	--	--	--	--	--	--	--
	GROOVED	222	251	267	330	387	508	--	--	--	--	--	--
	150# FLGD	216	238	267	305	381	451	645	756	864	991	1026	1575
	300# FLGD	222	251	283	324	397	473	670	791	902	1029	1067	1619
B	SCREWED	37	43	48	57	--	--	--	--	--	--	--	--
	GROOVED	25*	30	37	44	57	84	--	--	--	--	--	--
	150# FLGD	59-64	76	89	95	114	140	171	203	241	270	298	406
	300# FLGD	67-78	83	95	105	127	159	191	222	260	292	324	457
C	SCREWED	111	121	152	165	--	--	--	--	--	--	--	--
	GROOVED	111*	121	152	165	194	--	--	--	--	--	--	--
	150# FLGD	108	121	152	152	191	254	322	378	432	--	529	--
ANGLE	300# FLGD	111	127	162	162	198	267	335	395	451	--	549	--
	SCREWED	79	98	102	114	--	--	--	--	--	--	--	--
	GROOVED	79*	98	102	114	143	--	--	--	--	--	--	--
D	150# FLGD	76	98	102	102	140	152	203	289	279	--	398	--
	300# FLGD	79	105	111	111	148	165	216	306	298	--	419	--
	ALL	152	152	178	165	203	254	302	391	432	457	483	686
F	ALL	98	98	98	98	98	98	162	162	162	162	162	203
G	ALL	152	171	195	222	298	356	533	622	711	794	876	1321
H	ALL	254	279	279	279	305	330	356	432	457	508	508	724

\*GROOVED END NOT AVAILABLE IN DN32

For maximum efficiency, the OCV control valve should be mounted in a piping system so that the valve bonnet (cover) is in the top position. Other positions are acceptable but may not allow the valve to function to its fullest and safest potential. In particular, please consult the factory before installing 8" and larger valves, or any valves with a limit switch, in positions other than described. Space should be taken into consideration when mounting valves and their pilot systems.

A routine inspection & maintenance program should be established and conducted yearly by a qualified technician. Consult our factory @ **1-888-628-8258** for parts and service.

#### How to order your valve

When Ordering please provide:  
 Series Number - Valve size - Globe or Angle -  
 Pressure Class - Screwed, Flanged, Grooved -  
 Trim Material - Adjustment Range - Pilot  
 Options - Special needs / or installation requirements.

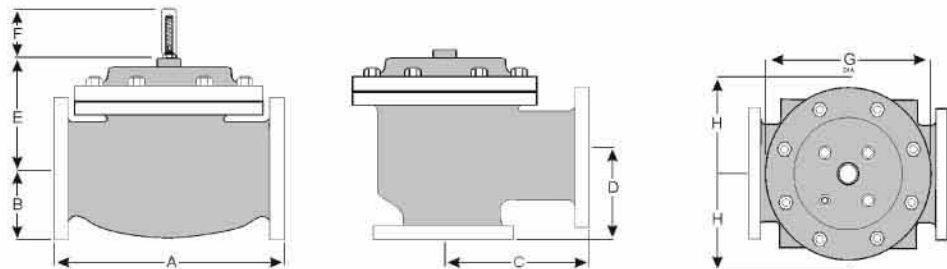

Represented by:

**TOLL FREE 1.888.628.8258** • phone: (918)627.1942 • fax: (918)622.8916 • 7400 East 42nd Place, Tulsa, Oklahoma 74145  
 email: sales@controlvalves.com • website: www.controlvalves.com

**Global performance. Personal touch.**